

COMP *A-I-R*™ Pro
Compressor Nebuliser
Model NE-C29-E

-
- **Instruction Manual**
 - **Mode d'emploi**
 - **Gebrauchsanweisung**
 - **Manuale di istruzioni**
 - **Manual de instrucciones**
 - **Gebruiksaanwijzing**
 - **РУКОВОДСТВО ПО ЭКСПЛУАТАЦИИ**

• **كتيب الإرشادات**

EN

FR

DE

IT

ES

NL

RU

AR

Contents

Before using the unit

| | |
|--|---|
| Introduction | 3 |
| Intended use | 3 |
| Important safety instructions..... | 4 |
| 1. Know your unit..... | 7 |
| 2. Guide to using the Comp Air Pro | 9 |

Operating instructions

| | |
|--|----|
| 3. Preparing the nebuliser for use | 10 |
| 4. Taking medication | 14 |

Care and maintenance

| | |
|---|----|
| 5. Cleaning and daily disinfecting | 17 |
| 5.1 Cleaning..... | 17 |
| 5.2 Disinfecting the nebulising parts | 18 |
| 6. Maintenance and storage | 20 |
| 7. Changing the air filter..... | 21 |
| 8. Troubleshooting..... | 22 |
| 9. Technical data | 23 |
| 10. Optional parts and accessories..... | 27 |

Introduction

Thank you for purchasing the OMRON Comp Air Pro.

This product was developed in conjunction with respiratory therapists for the successful treatment of asthma, chronic bronchitis, allergies and other respiratory disorders. The compressor forces air to the nebuliser. When the air enters the nebuliser, it converts the prescribed medication into an aerosol of microscopic droplets that can easily be inhaled.

The Comp Air Pro is a medical device. Operate this device only as instructed by your doctor and/or respiratory therapist.

Intended use

| | | | | | | | | | | | | | | | |
|--|--|-----------|---------|--|----------|------------|----------|----------|----------|------------|---------|------------|----------|------------------------|----------|
| Medical Purpose | This product is intended to be used for inhaling medication for respiratory disorders. | | | | | | | | | | | | | | |
| Intended User | <ul style="list-style-type: none">• Legally certified medical experts, such as doctor, nurse and therapist, or healthcare personnel or patient under the guidance of qualified medical experts.• The user should also be capable of understanding general machine operation and the content of instruction manual. | | | | | | | | | | | | | | |
| Intended Patients | This product should not be used by patients, who are unconscious or are not breathing spontaneously. | | | | | | | | | | | | | | |
| Environment | This product is intended for use in a medical facility, such as Hospital, clinic and doctor's office, and in a room of general household. | | | | | | | | | | | | | | |
| Durable period | <p>Durable periods are as follows, provided the product is used to nebulise saline 10 times a day for 10 minutes each time at room temperature (23°C).</p> <p>Durable period may vary depending on usage environment.</p> <table><tr><td>Main unit</td><td>3 years</td></tr><tr><td>Nebuliser Kit (Cap, Inhalation Air Inlet, Baffle, Medication Cup)</td><td>100 days</td></tr><tr><td>Mouthpiece</td><td>100 days</td></tr><tr><td>Air Tube</td><td>100 days</td></tr><tr><td>Air Filter</td><td>60 days</td></tr><tr><td>Child Mask</td><td>100 days</td></tr><tr><td>Adapter for Child Mask</td><td>100 days</td></tr></table> | Main unit | 3 years | Nebuliser Kit (Cap, Inhalation Air Inlet, Baffle, Medication Cup) | 100 days | Mouthpiece | 100 days | Air Tube | 100 days | Air Filter | 60 days | Child Mask | 100 days | Adapter for Child Mask | 100 days |
| Main unit | 3 years | | | | | | | | | | | | | | |
| Nebuliser Kit (Cap, Inhalation Air Inlet, Baffle, Medication Cup) | 100 days | | | | | | | | | | | | | | |
| Mouthpiece | 100 days | | | | | | | | | | | | | | |
| Air Tube | 100 days | | | | | | | | | | | | | | |
| Air Filter | 60 days | | | | | | | | | | | | | | |
| Child Mask | 100 days | | | | | | | | | | | | | | |
| Adapter for Child Mask | 100 days | | | | | | | | | | | | | | |
| Precautions for use | Warnings and cautions described in the instruction manual should be observed. | | | | | | | | | | | | | | |

EN

Important safety instructions

Read all the information in the instruction manual and any other literature included in the box before using the device.

When using an electrical product, especially when children are present, basic safety precautions should always be followed including the following:

⚠ Warning:

Indicates a potentially hazardous situation which, if not avoided, could result in serious injury.

(Usage)

- For type, dose, and regime of medication follow the instructions of your doctor or respiratory therapist.
- Do not use only water in the nebuliser, for nebulising purposes.
- Clean and disinfect the nebuliser kit, mouthpiece and optional nosepiece or masks before using them for the first time after purchase, if the device has not been used for a long period of time, or if more than one person uses the same device.
- Be sure to wash the parts after use, and ensure that they are thoroughly disinfected and dried, and stored in a clean location.
- Keep the device out of the reach of unsupervised infants and children. The device may contain small pieces that can be swallowed.
- Store the device and accessories in a clean location.
- Do not store the air tube while there is moisture or medication remaining inside it.
- Always rinse the nebulising parts with clean hot tap water after disinfecting them. Never leave the cleaning solution in the medication tank or mouthpiece.
- Do not use or store the device where it may be exposed to noxious fumes or volatile substances.
- Do not use the device where it may be exposed to flammable gas.
- Do not block the ventilation slots. Never place the device where the ventilation slots may be obstructed during operation. Do not cover the compressor with a blanket or towel etc., during use.
- Make sure that the nebuliser kit is clean before use.
- Always dispose of any remaining medication after use, and use fresh medication each time.
- Do not use in anaesthetic or ventilator breathing circuits.

(Risk of electrical shock)

- Never unplug the power cord with wet hands.
- The compressor and power cord are not waterproof. Do not spill water, or other liquids, on these parts. If liquid does spill on these parts, immediately unplug the power cord and wipe off the liquid with gauze or other absorbent material.

- Do not immerse the main unit in water or other liquid.
- Do not use or store the device in humid locations, such as a bathroom.
- Do not operate the unit with a damaged cord or plug.
- Keep the power cord away from heated surfaces.

Read and follow the “Important information regarding Electro Magnetic Compatibility (EMC)” in the Technical Data Section.

⚠ Caution:

Indicates a potentially hazardous situation which if not avoided, may result in minor or moderate injury, or physical damage.

(Usage)

- Provide close supervision when this device is used by, on, or near children or invalids.
- Make sure that the parts are attached correctly.
- Make sure that the vaporiser head is correctly installed before use.
- Make sure that the air filter is correctly attached.
- Make sure that the air filter is clean. If the air filter has changed colour, or has been used on average for more than 60 days, replace it with a new one.
- Do not spill liquid or medication on the compressor.
- Do not tilt the nebuliser kit so that it is at an angle of greater than 45°, or shake it while in use.
- Do not use or store the device while the air tube is creased.
- Use only original nebulising parts, air tube, air filter and filter cover.
- Do not add more than 7 ml of medication to the medication tank.
- Do not carry or leave the nebuliser kit while the medication tank contains medication.
- Do not leave the unit unattended with infants or persons who cannot express their consent.
- Do not subject the device or the parts to any strong shocks such as dropping the device on the floor.
- Do not distort the vaporiser head, or jab the nozzle of the medication tank with a pin etc.
- Do not insert fingers or objects inside the compressor.
- Do not disassemble or attempt to repair the compressor or power cord.
- Do not block the air filter cover.
- When sterilising parts by boiling, make sure that the container does not boil dry.
- Never place, or attempt to dry the compressor, the power cord or nebuliser in a microwave oven.
- Do not use the device while sleeping or if drowsy.

- To avoid injury to the nose mucosa, do not squeeze the nosepiece into the back of the nose.
- Do not block the slit between the cap and the inhalation air inlet.
- Do not use a microwave oven or hair dryer to dry the nebulising parts.
- Approved for human use only.

(Risk of electrical shock)

- Always unplug the device from the power outlet after use and before cleaning.
- Plug the device into the appropriate voltage outlet. Do not overload power outlets or use extension cords.
- Do not wind the power cord around the main unit.

- Changes or modifications not approved by OMRON Healthcare will void the user warranty.

General Safety Precautions:

- Inspect the device and parts before using them each time, and check that there are no problems. In particular, be sure to check the following:
 - That the vaporiser head, nozzle or air tube are not damaged.
 - That the nozzle is not blocked.
 - That the compressor operates normally.
- When using this device, there will be some noise and vibration caused by the pump in the compressor. There will also be some noise caused by the emission of compressed air from the nebuliser kit. This is normal and does not indicate a malfunction.
- Operate the device only as intended. Do not use the device for any other purpose.
- Do not use the device at temperatures greater than +40°C.
- Make sure that the air tube is securely attached to the compressor (main unit) and nebuliser kit, and does not come loose. Twist the airtube plug slightly when inserting it into the connectors to avoid the tube disconnecting during use.
- The plug is provided so that the unit can be completely isolated from the power source. To completely isolate the unit from the power source unplug the plug from the power source.

Read and follow the “Correct Disposal of This Product” in the Technical Data Section when disposing of the device and any used accessories or optional parts.

Save these instructions for future reference.

1. Know your unit

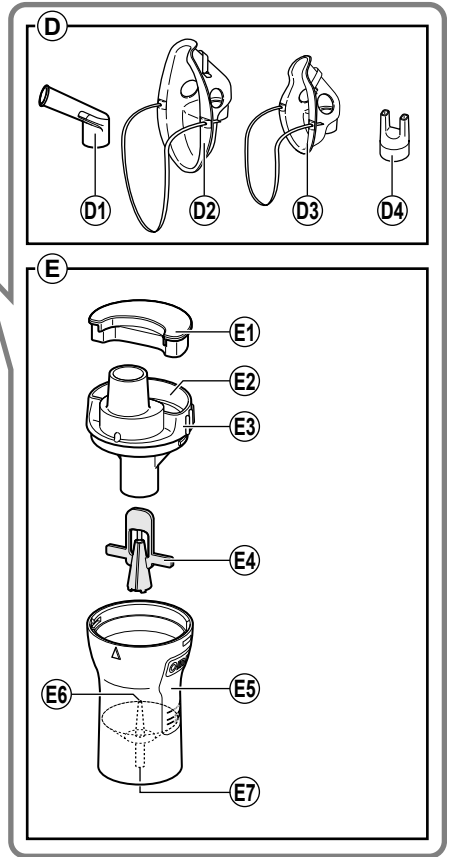
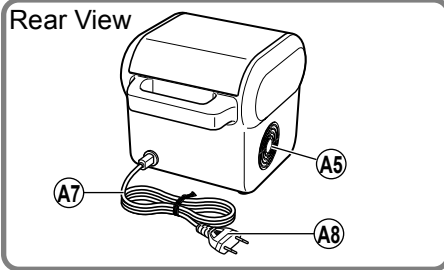
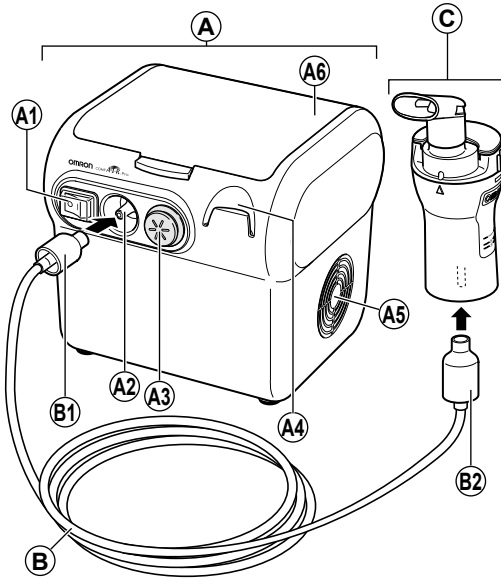

- A. Compressor (Main Unit)
 - A1. Power Switch
 - A2. Air Connector
 - A3. Filter Cover (* Air filter inside.)
 - A4. Nebuliser Kit Holder
 - A5. Ventilation Slots
 - A6. Storage Compartment Cover
 - A7. Power Cord
 - A8. Power Plug
- B. Air Tube (PVC, 207cm)
 - B1. Air Plug
 - B2. Air Plug
- C. Nebulising Parts

- D. Inhalation Attachments
 - D1. Mouthpiece
 - D2. Adult Mask (PVC)
 - D3. Child Mask (PVC)
 - D4. Nosepiece
- E. Nebuliser Kit
 - E1. Cap
 - E2. Inhalation Air Inlet
 - E3. Inhalation Top
 - E4. Vaporiser Head
 - E5. Medication Tank
 - E6. Nozzle
 - E7. Air Tube Connector

Accessories

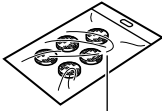

F

F. Spare Air Filters x 5

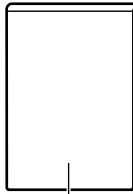

G

G. Instruction Manual

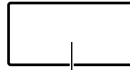

H

H. Warranty Card

Material of attachment

Nebuliser Kit, Mouthpiece, Nosepiece, Adapter for Child Mask (SEBS):

Polypropylene

Adult Mask (PVC), Child Mask (PVC):

PVC

Adult Mask (SEBS), Child Mask (SEBS):

SEBS

Air Tube:

PVC and Polypropylene

Air Filter:

Polyester

Air Filter Cover:

ABS

- Also applicable Section 10. Optional parts and accessories.

2. Guide to using the Comp Air Pro

Preparing the Nebuliser for Use (Section 3)

Note: Clean and disinfect the nebuliser kit and applicable inhalation attachments before using the device for the first time, or if it has not been used for more than one week.



Taking Medication (Section 4)

Notes:

- Do not tilt the nebuliser kit so that it is at an angle of greater than 45°.
- Do not crease or fold the air tube.

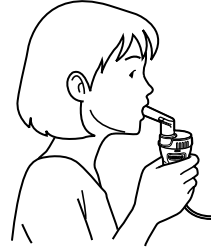

Cleaning Parts After Use (Section 5)

Note: Failure to clean the nebulising parts after use may lead to infection.

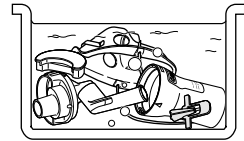

How the nebuliser kit works

The compressed air from the compressor is forced through the nozzle, as it does so, it is mixed with the medication in the vaporiser head and forced upwards. The medication is then turned into a fine aerosol and directed upwards by the baffle, where it is broken down into many smaller aerosol particles.

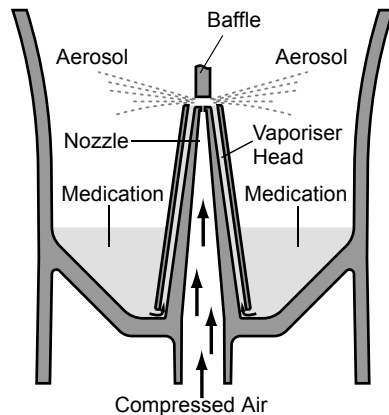

3. Preparing the nebuliser for use

⚠ Warning:

Clean and disinfect the nebuliser kit, mouthpiece and optional nosepiece or masks before using them for the first time after purchase, if the device has not been used for a long period of time, or if more than one person uses the same device.

For directions on cleaning and disinfecting the parts of the device refer to Section 5 in this instruction manual.

Note: Make sure that the air filter is changed regularly. (See Section 7 “Changing the air filter”.)

-
1. Make sure that the power switch is turned off.

Check that the power switch is in the **○** position.

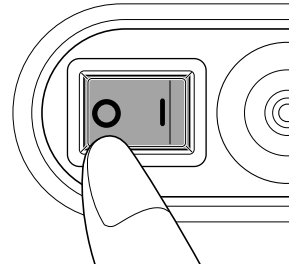

-
2. Plug the power plug into a power outlet.

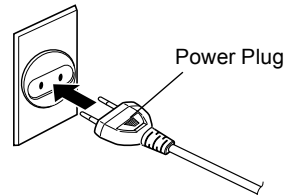

-
3. Remove the mouthpiece and cap from the nebuliser kit.

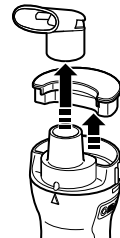

-
4. Remove the inhalation top from the medication tank.

- 1) Rotate the inhalation top anti-clockwise.
- 2) Lift the inhalation top out of the medication tank.

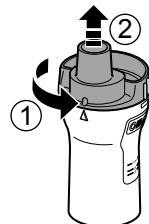

5. Remove the vaporiser head from the medication tank.



6. Add the correct amount of prescribed medication to the medication tank.

⚠ Caution:

The capacity of the medication tank is 2 to 7 ml.

Note: Scales on the nebuliser kit are for reference only. The scale on the outside of the tank is with vaporiser head in place. The scale on the inside is with no vaporiser head. Please use the scale on your syringe or vial for accurate measurement of medication.



7. Reattach the vaporiser head to the medication tank.



8. Put the inhalation top back inside the medication tank.

- 1) Align the protrusion on the inhalation top with the indent on the medication tank, as shown.
- 2) Rotate the inhalation top clockwise and align with the medication tank until they click in place.

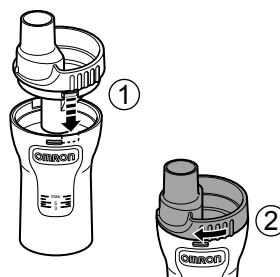

EN

9. Attach the desired inhalation attachment, as described below.

Attaching the mouthpiece

Make sure you also attach the cap, when using the mouthpiece.

- 1) Attach the cap to the inhalation air inlet.
- 2) Attach the mouthpiece to the inhalation top.

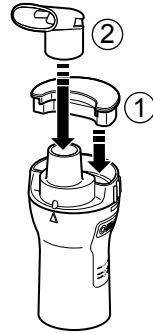

Attaching the adult mask (PVC)

Attach the mask to the inhalation top.

Note: If the amount of aerosol is too great, attach the cap.

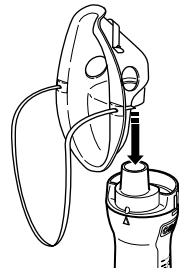

Attaching the child mask (PVC)

Attach the mask to the inhalation top.

- 1) Attach the cap to the inhalation air inlet.
- 2) Attach the child mask to the inhalation top.

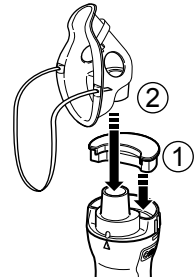

Attaching the nosepiece

Attach the cap when using the nosepiece.

- 1) Attach the cap to the inhalation air inlet.
- 2) Attach the nosepiece to the inhalation top.

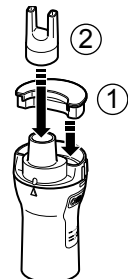

10. Attach the air tube.

- 1) Attach the air tube to the air connector on the compressor.
- 2) Attach the other end of the air tube to the air tube connector on the medication tank.

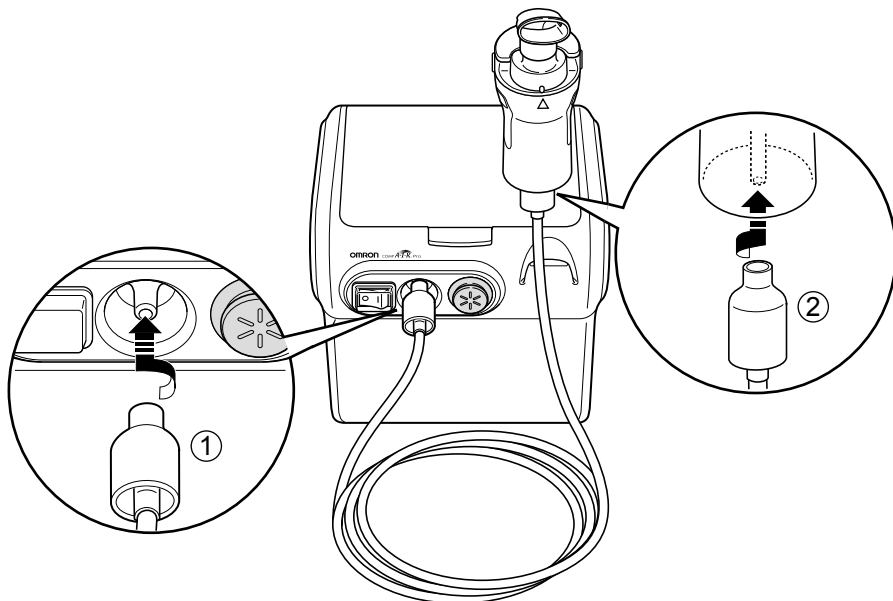
**Notes:**

- Make sure that the air tube is securely attached to the compressor (main unit) and nebuliser kit, and does not come loose. Twist the airtube plug slightly when inserting it into the connectors to avoid the tube disconnecting during use.
- Take care not to spill the medication when attaching the air tube. Keep the nebuliser kit upright.
- Use the nebuliser kit holder as a temporary holder for the nebuliser kit.

EN

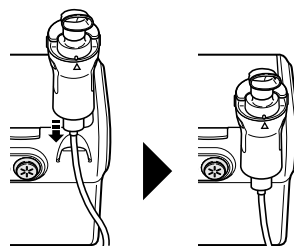

4. Taking medication

1. Hold the nebuliser kit as indicated on the right.

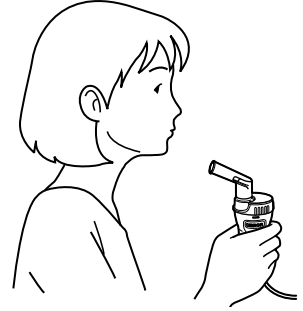

⚠ Caution:

Do not tilt the nebuliser kit so that it is at an angle of greater than 45°. Medication may flow into the mouth.

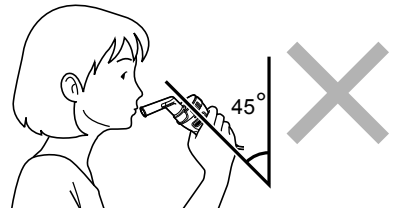

2. Press the power switch to the on (|) position.

The compressor starts and nebulisation starts.

Note: Observe whether aerosol is generated.

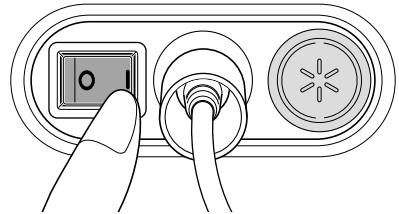

To stop nebulisation

Press the power switch to the off (○) position.

⚠ Warning:

Do not block the ventilation slots on the compressor. This could result in the compressor overheating or malfunctioning.

⚠ Caution:

Do not block the air filter cover.

Note: Do not leave the compressor on for a long period of time. This could result in the compressor overheating or malfunctioning.

3. Inhale medication according to your doctor's and/or health care adviser's instructions.

Using the mouthpiece

Prepare your mouthpiece according to Section 3.9.

Insert the mouthpiece into your mouth and inhale the medication breathing normally. Exhale as normal through the mouthpiece.

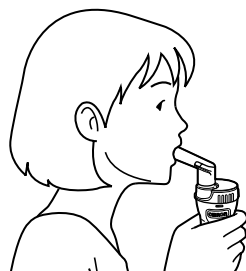

Using the nosepiece

Prepare your nosepiece according to Section 3.9.

Inhale the medication through the nosepiece, as shown and exhale through the mouth.



Using the adult mask (PVC)

Attach the mask so that it covers your nose and mouth and inhale the medication. Exhale through the mask.

Note: If the amount of aerosol is too great, attach the cap.

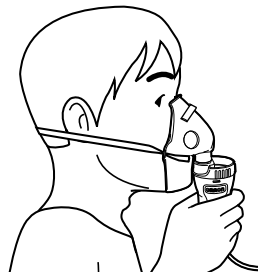

Using the child mask (PVC)

Prepare your child mask according to Section 3.9.

Attach the mask so that it covers your nose and mouth and inhale the medication. Exhale through the mask.

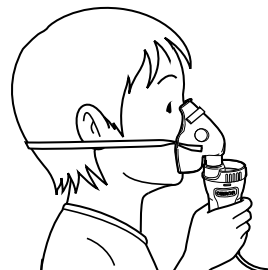

EN

4. When treatment is complete, turn the power off. Check that there is no condensation or moisture in the air tube and unplug the device from the power outlet.

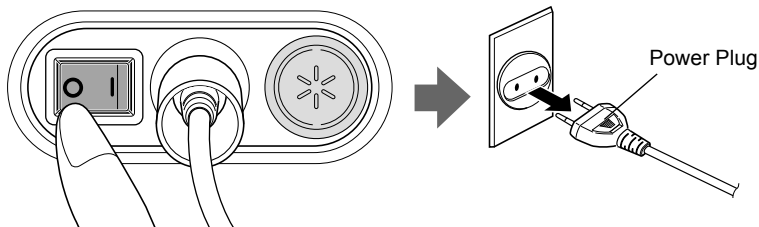

⚠ Warning:

Condensation may occur in the air tube. Do not store the air tube while it contains condensation or moisture. This could result in infection via bacteria.

If there is moisture or liquid remaining in the air tube, be sure to follow the procedure below to remove any moisture from within the air tube.

- 1) Make sure that the air tube is still connected to the air connector on the compressor.
- 2) Unplug the air tube from the nebuliser kit.
- 3) Turn on the compressor and pump air through the air tube to expel the moisture.

5. Cleaning and daily disinfecting

5.1 Cleaning

Following the cleaning instructions after each use will prevent any remaining medication in the tank from drying, resulting in the device not nebulising effectively and also for preventing infections.

⚠ Warning:

Thoroughly rinse the nebuliser and the mask, nosepiece or mouthpiece with clean hot tap water after each use, and disinfect the parts of the nebuliser kit and applicable inhalation attachments after the last treatment of the day.

Note: Do not start operation before the cleaned parts are completely dried.

1. Make sure that the power switch is in the **○** (off) position.
2. Unplug the power cord from the electrical outlet.
3. Remove the nebuliser kit from the air tube and disassemble the nebuliser kit. (see Section 3)
4. Discard any remaining medication in the medication tank.

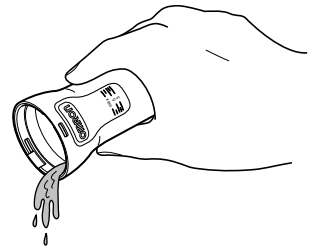

5. Wash all the nebulising parts in warm water and mild detergent and rinse in clean hot tap water, or wash in a dishwasher.

For instructions on how to disinfect the parts, see the following section.

6. After cleaning and disinfecting the parts, rinse them thoroughly with clean water and allow the parts to air dry in a clean environment.

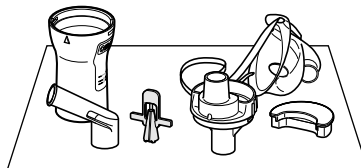

7. If the compressor is dirty, wipe it clean with a soft cloth moistened with water or mild detergent.

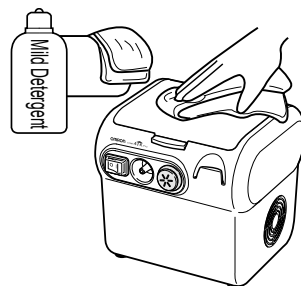

⚠ Caution:

The compressor is not waterproof.

-
8. If the outside of the air tube is dirty, wipe it clean with a soft cloth moistened with water or mild detergent.

-
9. Store the parts in the storage compartment in the compressor.

Note: Make sure that the parts are clean and dry. Do not place parts in the storage compartment if they are still wet.

Store the unit in a clean and dry location.

Note: Nebuliser kit should be replaced after using for 6 months.

5.2 Disinfecting the nebulising parts

Always clean before disinfection. (See Section 5.1)

Always disinfect the medication tank, mouthpiece and other nebulising parts after the last treatment of the day. To disinfect the parts, use one of the methods described below:

A. Use a commercially available disinfectant. Follow the instructions provided by the disinfectant manufacturer.

-
1. Submerge the parts in the cleansing solution for the specified period.

 2. Remove the parts and discard the solution.

 3. Rinse the parts with clean hot tap water, shake off excess water and allow to air dry in a clean environment.

B. Parts may be boiled between 15 to 20 minutes (except for PVC mask).

After boiling, carefully remove the parts, shake off excess water and allow to air dry in a clean environment.

Handling the Vaporiser Head

The vaporiser head is an important part that is used to vaporise medication. Be sure to observe the following precautions when handling it.

⚠ Caution:

- **Always wash the vaporiser head after each use. Failure to do so could cause blockages and a deterioration in your condition due to a failure to vaporise medication effectively.**
- **Do not use a brush or pin etc., to clean the parts. This could damage the baffle and cause a deterioration in your condition due to a failure to vaporise medication effectively.**
- **When disinfecting the parts by boiling, be sure to boil them in plenty of water. If there is insufficient water, the parts could become distorted due to the high temperature near the bottom of the pan. Distorted parts could cause a deterioration in your condition due to a failure to vaporise medication effectively.**
- **Do not boil vaporiser head together with other objects, other than applicable nebuliser accessories. This could damage the baffle and cause a deterioration in your condition due to a failure to vaporise medication effectively.**
- **Do not use a microwave oven, dish dryer or hair dryer to dry parts. The parts could become distorted due to the high temperature and cause a deterioration in your condition due to a failure to vaporise medication effectively.**

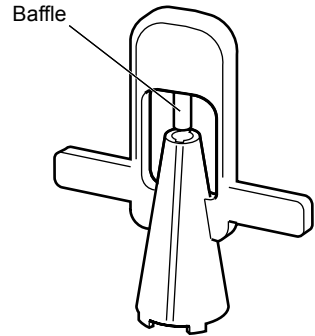

Vaporiser head

6. Maintenance and storage

To keep your device in the best condition and protect the device from damage follow these directions:

⚠ Caution:

- **Do not leave the unit unattended with infants or persons who cannot express their consent.**
- **Do not subject the device or the parts to any strong shocks such as dropping the device on the floor.**
- **Do not carry or leave the nebuliser while the medication tank contains medication.**

Notes:

- Do not store the device in extreme hot or cold temperatures, high humidity or under direct sunlight.
- Do not crease or fold the air tube.
- Dispose of the device and any used accessories or optional parts according to applicable local regulations.
- Never clean with benzene, thinner or a flammable chemical.



7. Changing the air filter

On average, the air filter should be changed every 60 days or so, or when the filter has changed colour from white.

1. Pull the air filter cover off the compressor.

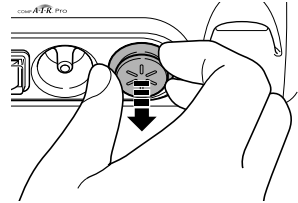

2. Change the air filter.

Remove the old air filter with a sharp object, such as a toothpick, and insert the new air filter.

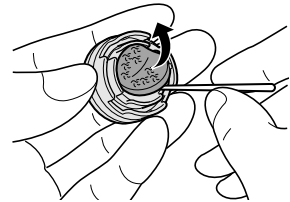

3. Put the air filter cover back in place.

Notes:

- Use only OMRON air filters designed for this unit. Do not operate without a filter.
- There is no front or back orientation for the air filters.
- Check that air filters are clean and free of dust before inserting them.
- Do not attempt to wash or clean the filter. If the air filter becomes wet, replace it. Damp air filters can cause blockages.
- To prevent the air filter cover from becoming blocked, wash the cover regularly. Do not boil the air filter cover. Remove the air filter cover, wash it, and make sure it is dry and reattached correctly.
- Please contact your OMRON dealer for additional air filters, or if the parts supplied with the device are damaged or missing.

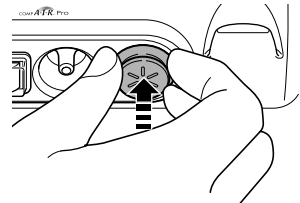

8. Troubleshooting

Check the following if your unit should fail during operation. You can also refer to the pages of this manual for complete instructions.

| Symptom | Cause | Remedy |
|---|---|--|
| Nothing happens when the power switch is pressed. | Is the power plug plugged into an electrical outlet? | Check that the plug is inserted in an electrical outlet. Unplug then reinsert the plug if necessary. |
| No nebulisation or low nebulisation rate, when the power is on. | Is there medication in the medication tank? | Fill the medication tank. |
| | Is there too much/little medication in the medication tank? | Add the correct amount of medication to the medication tank. |
| | Is the vaporiser head missing and not assembled correctly? | Attach the vaporiser head correctly. |
| | Is the nebuliser kit assembled correctly? | Assemble the nebuliser kit correctly. |
| | Is the nozzle blocked? | Make sure that the nozzle is free of blockages. |
| | Is the nebuliser kit tilted at a sharp angle? | Make sure that the nebuliser kit is not tilted at an angle of more than 45 degrees. |
| | Is the air tube connected correctly? | Make sure that the air tube is correctly connected to the compressor and nebuliser. |
| | Is the air tube folded or damaged? | Make sure that the air tube does not contain kinks. |
| | Is the air tube blocked? | Make sure that the air tube is free of blockages. |
| | Is the air filter dirty? | Replace the air filter with a new one. |
| The device is abnormally loud. | Is the air filter cover attached correctly? | Attach the air filter cover correctly. |
| The device is very hot. | Are the ventilation slots blocked? | Do not block the ventilation slots. |

Notes:

- If the suggested remedy does not solve the problem, do not try to repair the device - no parts of the unit are user serviceable.
Return the unit to an authorized OMRON retail outlet or distributor.
- The device should be serviced once a year by an approved OMRON service centre.

9. Technical data

| | |
|--|---|
| Name: | Comp Air Pro |
| Model: | OMRON NE-C29-E |
| Type: | Non-heating compressor nebuliser |
| Electrical: | 220 - 240V, 50/60 Hz |
| Power Consumption: | 192VA |
| Operating Temperature/ Humidity: | +10°C to +40°C 30% to 85% RH |
| Storage Temperature/ Humidity/Air Pressure: | -20°C to +60°C 10% to 95% RH 700 - 1060 hPa |
| Weight: | Approx. 2.3kg (compressor only) |
| Dimensions: | Approx. 186 (W) × 180 (H) × 216 (D) mm |
| Contents: | Compressor, Nebuliser Kit, Air Tube (PVC, 207cm), 5 pcs Replacement Filters, Mouthpiece, Adult Mask (PVC), Child Mask (PVC), Nosepiece, Instruction Manual. |

Notes:

- Subject to technical modification without prior notice.
- This OMRON product is produced under the strict quality system of OMRON Healthcare Co., Ltd., Japan.
- The device may not work if the temperature and voltage conditions are different to those defined in the specifications.

Technical data for the OMRON Comp Air Pro compressor with the OMRON V.V.T. (Virtual Valve Technology) Nebuliser kit:

| | |
|---|-------------------------------------|
| Particle Size: | *MMAD **approximately 3µm |
| Medication Tank Capacity: | 7 ml maximum |
| Appropriate Medication Quantities: | 2 ml minimum - 7 ml maximum |
| Sound: | Noise level (at 1 m distance) 60 db |
| Nebulisation Rate: | 0.4 ml/min (by weight loss) |
| Aerosol Output: | **0.4 ml (2ml, 1%NaF) |
| Aerosol Output Rate: | **0.06 ml/min (2ml, 1%NaF) |

Notes:

- Performance may vary with drugs such as suspensions or high viscosity. See drug supplier’s data sheet for further details.
- The data above is referenced by Omron Healthcare.
- See web site of Omron Healthcare Europe to update technical information.

Result of cascade impactor **measurements for particle size with OMRON Comp Air Pro (NE-C29-E) and OMRON V.V.T. Nebuliser kit

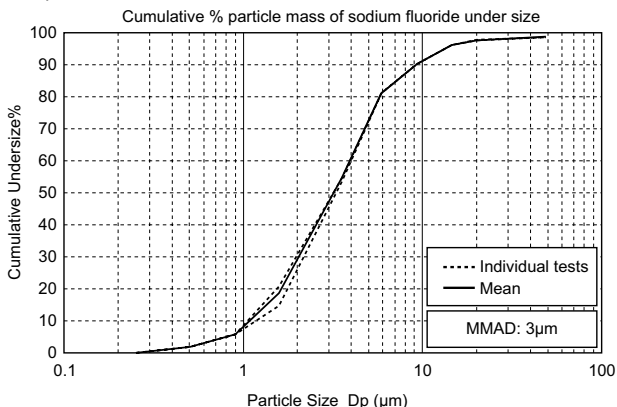

*MMAD = Mass Median Aerodynamic Diameter

** Independently measured at SolAero Ltd., Canada, Dr. John Dennis, according to EN 13544-1

Notes:

 = Type B **CE 0197**

- Do not use the device where it may be exposed to flammable gas.
- This device fulfils the provisions of the EC directive 93/42/EEC (Medical Device Directive) and the European Standard EN13544-1:2007, Respiratory therapy equipment - Part1: Nebulizing systems and their components.



= Class II



= Read the instruction manual carefully

Important information regarding Electro Magnetic Compatibility (EMC)

With the increased number of electronic devices such as PC's and mobile (cellular) telephones, medical devices in use may be susceptible to electromagnetic interference from other devices. Electromagnetic interference may result in incorrect operation of the medical device and create a potentially unsafe situation.

Medical devices should also not interfere with other devices.

In order to regulate the requirements for EMC (Electro Magnetic Compatibility) with the aim to prevent unsafe product situations, the EN60601-1-2 standard has been implemented. This standard defines the levels of immunity to electromagnetic interferences as well as maximum levels of electromagnetic emissions for medical devices.

This medical device manufactured by OMRON Healthcare conforms to this EN60601-1-2:2007 standard for both immunity and emissions.

Nevertheless, special precautions need to be observed:

- Do not use mobile (cellular) telephones and other devices, which generate strong electrical or electromagnetic fields, near the medical device. This may result in incorrect operation of the unit and create a potentially unsafe situation. Recommendation is to keep a minimum distance of 7 m. Verify correct operation of the device in case the distance is shorter.

Further documentation in accordance with EN60601-1-2:2007 is available at OMRON Healthcare Europe at the address mentioned in this instruction manual.

Documentation is also available at www.omron-healthcare.com.



***Correct Disposal of This Product
(Waste Electrical & Electronic Equipment)***





This marking shown on the product or its literature, indicates that it should not be disposed of, with other household wastes at the end of its working life. To prevent possible harm to the environment or human health from uncontrolled waste disposal, please separate this from other types of wastes and recycle it responsibly to promote the sustainable reuse of material resources.

Household users should contact either the retailer where they purchased this product, or their local government office, for details of where and how they can take this item for environmentally safe recycling.

Business users should contact their supplier and check the terms and conditions of the purchase contract. This product should not be mixed with other commercial wastes for disposal.

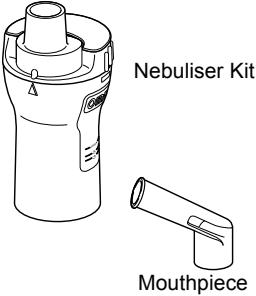
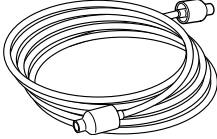
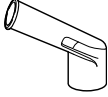
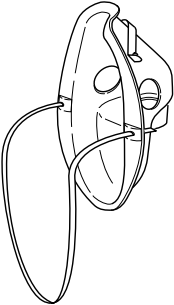
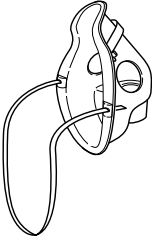
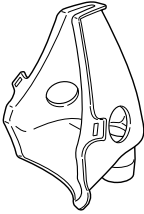
This product does not contain any hazardous substances.

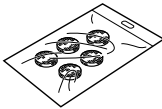
10. Optional parts and accessories

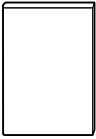
| | | |
|---|---|---|
| <p>Omron V.V.T. Nebuliser Kit Set Order No. 9956268-9</p>  <p>Nebuliser Kit</p> <p>Mouthpiece</p> | <p>Air Tube (PVC, 207cm) Order No. 9956270-0</p>  | <p>Mouthpiece Order No. 9956273-5</p>  |
| <p>Adult Mask (PVC) Order No. 9956275-1</p>  | <p>Child Mask (PVC) Order No. 9956276-0</p>  | <p>Adult Mask (SEBS) Order No. 9956312-0</p>  |
| <p>Child Mask (SEBS) Set Order No. 9956281-6</p>  <p>Child Mask (SEBS)</p> <p>Adapter for Child Mask (SEBS)</p> | <p>Air Filters (x 5) Order No. 9956271-9</p>  | <p>Filter Cover Order No. 9956272-7</p>  |
| <p>Instruction Manual Order No. 9956267-0</p>  | | |

| | | | |
|---|--|-----|--|
| Manufacturer  | OMRON HEALTHCARE Co., Ltd. 53, Kunotsubo, Terado-cho, Muko, Kyoto, 617-0002 JAPAN | | |
| EU-representative <table border="1" data-bbox="120 312 277 376"> <tr> <td data-bbox="120 312 199 376">EC</td> <td data-bbox="199 312 277 376">REP</td> </tr> </table> | EC | REP | OMRON HEALTHCARE EUROPE B.V. Scorpius 33, 2132 LR Hoofddorp THE NETHERLANDS www.omron-healthcare.com |
| EC | REP | | |
| Production facility | OMRON (DALIAN) CO., LTD. Dalian, CHINA | | |
| Subsidiary | OMRON HEALTHCARE UK LTD. Opal Drive Fox Milne, Milton Keynes, MK15 0DG, U.K. | | |
| | OMRON MEDIZINTECHNIK HANDELSGESELLSCHAFT mbH John-Deere-Str. 81a, 68163 Mannheim, GERMANY www.omron-medizintechnik.de | | |
| | OMRON SANTÉ FRANCE SAS 14, rue de Lisbonne, 93561 Rosny-sous-Bois Cedex, FRANCE | | |

Made in China

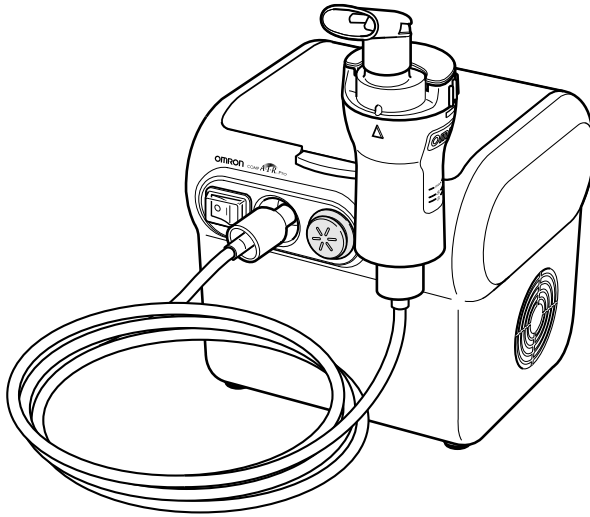

COMP *A-I-R*™ Pro
Nébuliseur à compresseur
Modèle NE-C29-E

- **Instruction Manual**
- **Mode d'emploi**
- **Gebrauchsanweisung**
- **Manuale di istruzioni**
- **Manual de instrucciones**
- **Gebruiksaanwijzing**
- **РУКОВОДСТВО ПО ЭКСПЛУАТАЦИИ**

• **كتيب الإرشادات**

EN

FR

DE

IT

ES

NL

RU

AR